



# USER MANUAL FOR THE 3.5 GENERATION FULLY AUTOMATIC ULTRASONIC WATCH CLEANING MACHINE





**CRAFTED  
BRILLIANCE**

# TABLE OF CONTENTS ▶▶▶

## 01.PRODUCT OVERVIEW

KEY FUNCTIONS & FEATURES	-----	01
--------------------------	-------	----

## 02.PRODUCT SPECIFICATIONS

DETAILED SPECIFICATIONS	-----	02
-------------------------	-------	----

PACKING LIST	-----	02
--------------	-------	----

## 03.SAFETY INSTRUCTIONS

OPERATING ENVIRONMENT OF THE WATCH CLEANING MACHINE	-----	03
---	-------	----

POWER CONNECTION	-----	03
------------------	-------	----

UNAUTHORIZED REPAIRS	-----	03
----------------------	-------	----

BASKET SHOWCASE	-----	04
-----------------	-------	----

SAFE OPERATION AND INSTALLATION GUIDE	-----	05
---------------------------------------	-------	----

## 04.INSTALLATION AND OPERATING INSTRUCTIONS

MACHINE INSTALLATION	-----	06
----------------------	-------	----

POWERING ON THE WATCH CLEANING MACHINE	-----	06
--	-------	----

SWITCHING COMPARTMENTS AND ADDING CLEANING SOLUTION	-----	07
---	-------	----

SETTING CLEANING SOLUTION REPLACEMENT REMINDER	-----	08
--	-------	----

USAGE OF THE BASKET	-----	09
---------------------	-------	----

WAY OF CLEANING MODE SETTING	-----	09
------------------------------	-------	----

CLEANING MODE SETTING	-----	10
-----------------------	-------	----

CLEANING AND SPIN-DRY TIME SETTING	-----	11
------------------------------------	-------	----

STARTING AND PAUSING THE PROGRAM	-----	11
----------------------------------	-------	----

USER SETTING	-----	12
--------------	-------	----

SYSTEM SETTING	-----	12
----------------	-------	----

SYSTEM LANGUAGE	-----	12
-----------------	-------	----

TIME SETTING	-----	13
--------------	-------	----

LIGHTING SETTING	-----	13
------------------	-------	----

VENTILATION FAN SETTINGS	-----	13
--------------------------	-------	----

## 05.WARRANTY AND AFTER-SALES SERVICE

WARRANTY TERMS	-----	14
----------------	-------	----

AFTER-SALES FRIENDLY REMINDER	-----	14
-------------------------------	-------	----

CONTACT US	-----	14
------------	-------	----



# CONGRATULATIONS!

## SELECTING OUR PRODUCT IS A WISE CHOICE.

You have purchased the Watchmaker 3.5 Generation Fully Automatic Ultrasonic Watch Cleaning machine, which equipped with precision technology. Specifically designed for watch service centers and watch repairing tools retailers, our watch cleaning machine is an ideal choice for daily watch cleaning.

Pre-set general cleaning programs and customizable, editable programs make the Watchmaker 3.5 Generation Fully Automatic Ultrasonic Watch Cleaning machine convenient and easy to use.

The pre-set universal watch cleaning procedures and customizable editable cleaning programs make our watch cleaning machine convenient and easy to use.

To avoid damaging the watch during the cleaning process, it is crucial to thoroughly understand the correct usage of the machine, this user manual assists users to operate the watch cleaning machine effectively and correctly, and provides instructions for the safe use and maintenance of the instrument.

Please keep this user manual in a safe place and provide it to new users when needed.

Extending the WATCHMAKER 3.5th GENERATION AUTOMATED ULTRASONIC WATCH CLEANING MACHINE's service life can be achieved by adhering to the provided instructions for optimal use and maintenance.

# 01 PRODUCT OVERVIEW

## KEY FUNCTIONS & FEATURES



### 3.5TH GENERATION AUTOMATED ULTRASONIC WATCH CLEANING MACHINE

AUTOMATIC CLEANING FUNCTION SPECIFICALLY DESIGNED FOR WATCH MOVEMENTS



#### KEY FUNCTIONS AND FEATURES:

- USER-FRIENDLY UI
- NEWLY-UPGRADED POWER SYSTEM
- VARIOUS AMBIENT LIGHTS
- FOUR-POSITION DESIGN
- SUPPORTS CHINESE/ENGLISH
- EQUIPPED WITH MULTIPLE CLEANING PROGRAMS
- CUSTOMIZABLE CLEANING PROGRAM SETTINGS
- MULTI-FUNCTIONAL CLEANING BASKETS
- TEMPERED GLASS JARS
- SEALED, DUST-FREE DESIGN FOR NOISE REDUCTION
- ULTRASONIC CLEANING FUNCTION
- EQUIPPED WITH A DRYING FUNCTION

# 02 PRODUCT OVERVIEW

## DETAILED SPECIFICATIONS & PACKING LIST



### DETAILED SPECIFICATIONS

PRODUCT NAME:	3.5TH GENERATION AUTOMATED ULTRASONIC WATCH CLEANING MACHINE
DIMENSION, L*W*H	405MM*440MM*690MM
NET WEIGHT:	53KG
PACKAGE SIZE	545MM*510MM*1050MM
TARE WEIGHT:	64KG
RATED POWER:	330W
FREQUENCY:	50(HZ)
RATED VOLTAGE:	110V-220V
LANGUAGE	CHINESE/ENGLISH

### PACKING LIST



WATCH CLEANING MACHINE\*1



GLASS JAR\*3



METAL CUP\*1



MEASURING CUP\*1



DOOR KNOB\*1



BASKET\*1



POWER PLUG\*1



PHASE DETECTOR\*1



PRODUCT MANUAL\*1

**Note: Kindly verify the receipt of all parts. Please don't hesitate to contact our customer service team if any parts are missing or damaged.**

# 03 SAFETY INSTRUCTIONS

## SAFETY INSTRUCTIONS



WHILE OPERATING THE WATCH CLEANING MACHINE, FOR YOUR SAFETY AND TO ENSURE PROPER MACHINE FUNCTION, PLEASE TAKE NOTE OF THE FOLLOWING:

### OPERATING ENVIRONMENT OF THE MACHINE:

To ensure optimal machine performance, place it in a room with a temperature between 18 to 28 degrees Celsius. Please avoid placing the machine near the hearth or open windows, and do not operate it outdoors in extreme hot or cold conditions.

### POWER CONNECTION:

The specific voltage requirement for the machine is 110V-220V. Please use a 10A three-hole socket and ensure proper grounding by connecting to the ground electrode. It is recommended to avoid sharing the same socket with other devices.

- ⓘ Before connecting to power, ensure that the machine's wiring is in good condition, and verify that the power switch appears to be in proper working order.

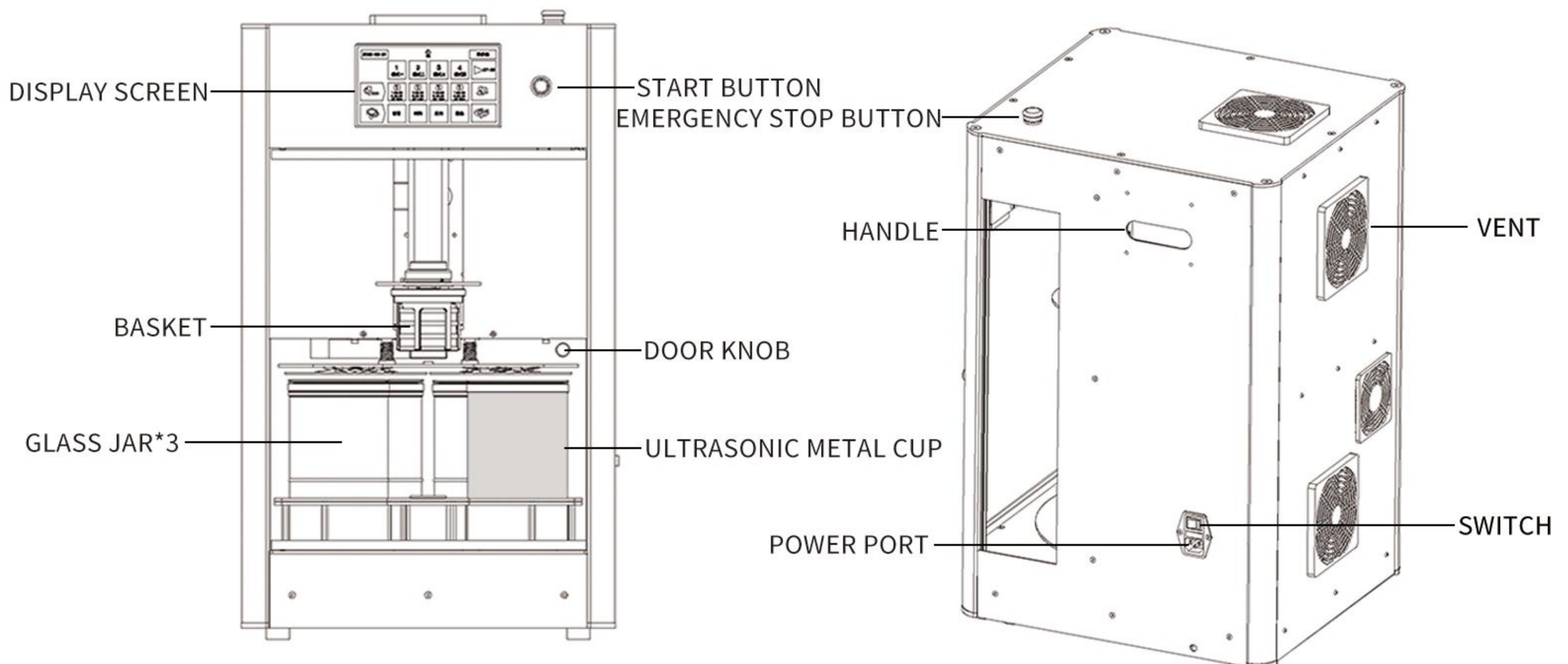

(The diagram illustrates each machine component in details)

### UNAUTHORIZED REPAIRS:

In the event of equipment malfunction, please contact the manufacturer's service center or an authorized repair center. Do not attempt to disassemble or repair the device yourself to prevent the risk of causing more severe issues or personal injury.



DO NOT OPERATE IN  
HIGH TEMPERATURES



DO NOT OPERATE IN  
LOW TEMPERATURES



USE THE PROVIDED  
POWER SUPPLY

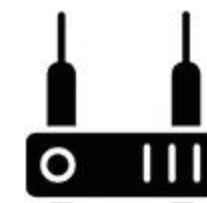

ACCURATE POWER  
CONNECTIONS



AUTHORIZED REPAIRS  
ONLY

# 03 SAFETY INSTRUCTIONS

## BASKET UTILIZATION GUIDE



### BASKET SHOWCASE



### BASKET COMPONENTS IN DETAILS



H-SHAPED BASKET WITH COMPARTMENTS



O-SHAPED BASKET



CROSS-SHAPED BASKET WITH COMPARTMENTS



STEEL SHEET



PLASTIC OUTER FRAME



SMALL-SIZED BASKET

**Note: When cleaning watch movements or small parts in the baskets, ensure that everything inside the baskets is securely fixed and immovable.**

# 03 SAFETY INSTRUCTIONS

---

## SAFE OPERATION & INSTALLATION GUIDE



### Safety Instructions and Installation Precautions:

- Remove the watch cleaner and accessories from the packaging and install them in the designated location. Ensure all fan outlets are unobstructed.
- Keep the packaging for potential returns or repairs.
- Please check and ensure that the watch cleaning machine and its accessories are received in full and without any damage.
- Please connect the watch cleaning machine to the power supply using the provided cable.
- Ensure there is sufficient ventilation in your working environment under normal conditions.
- Please clean the watch cleaning machine regularly and ensure the regular change of the cleaning solution. This helps maintain the cleaning performance of the equipment and prevents the formation of residue over time.
- Caution: Do not use gasoline or similar substances as a cleaning solution.
- Ensure that the liquid in the cup does not exceed the indicated line to prevent splattering.

# 04 INSTALLATION AND OPERATING INSTRUCTIONS

## MACHINE INSTALLATION&POWER ON

### 1. Machine installation:

After unpacking the machine, remove the protective film and install the door handle.

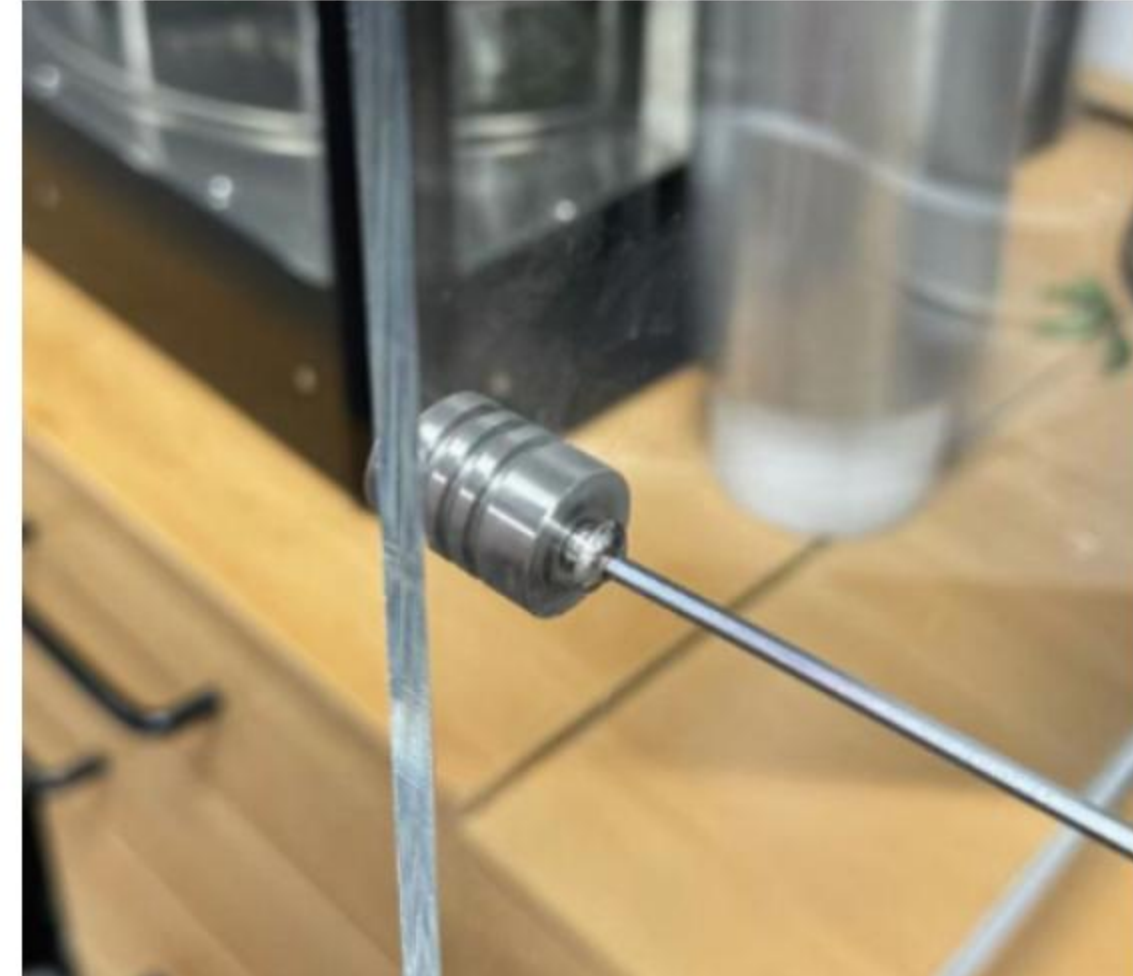

### 2. Powering on the watch cleaning machine:

Plug in the power cord and toggle the I/O switch on the side to turn on the watch cleaning machine. The cleaning compartments will automatically return to the set position after the machine is turned on. Please refrain from interfering with or conducting any operations during this process. The instrument is ready for use when the home page is displayed on the screen. You can initiate or select the cleaning process at this point.

**Note:** If the display shows "Emergency Stop" after startup, turn the red emergency stop button on top of the machine until it pops out. When the screen shows "Ready to Start," the machine can be used again.



# 04 INSTALLATION AND OPERATING INSTRUCTIONS

## COMPARTMENT SWITCH INTERFACE

### 3. Switching compartments and adding cleaning solution:

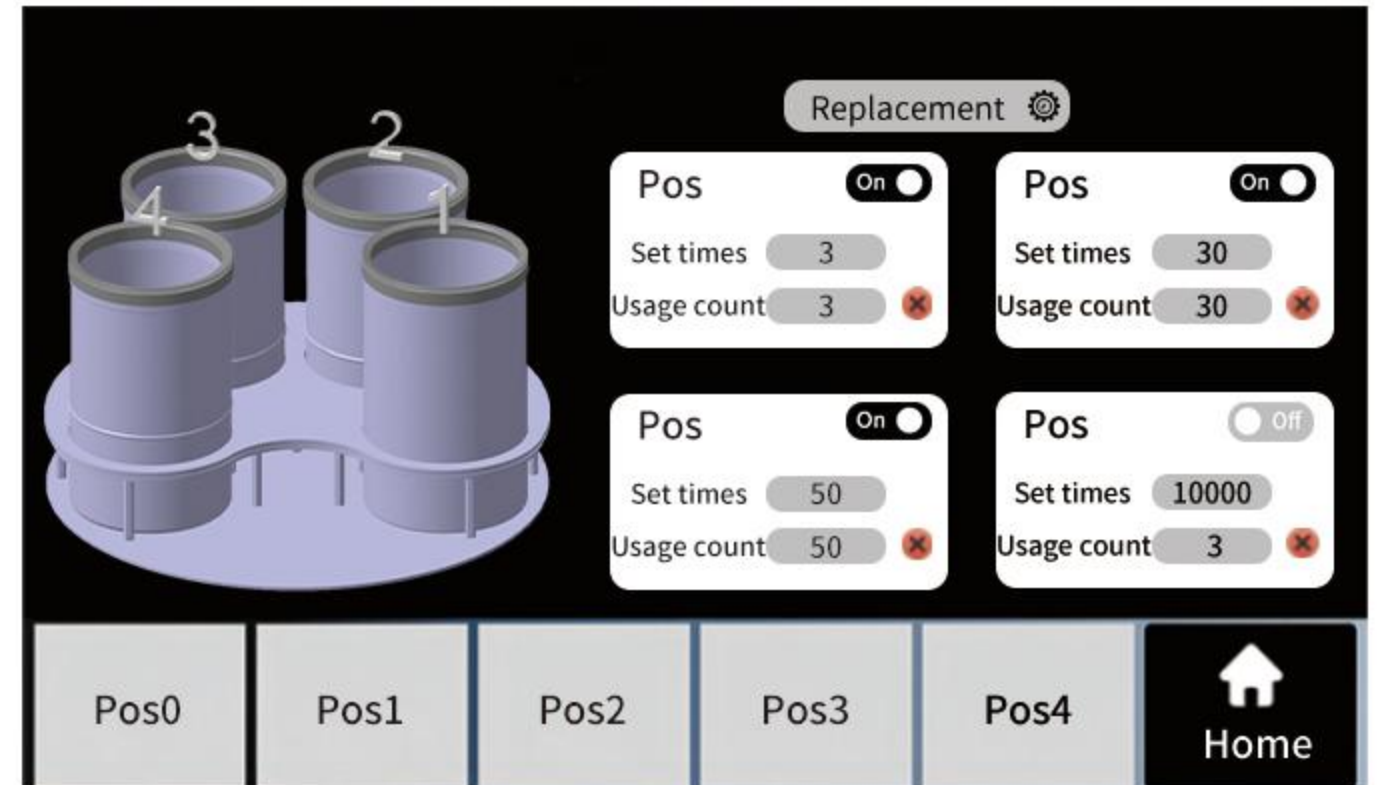
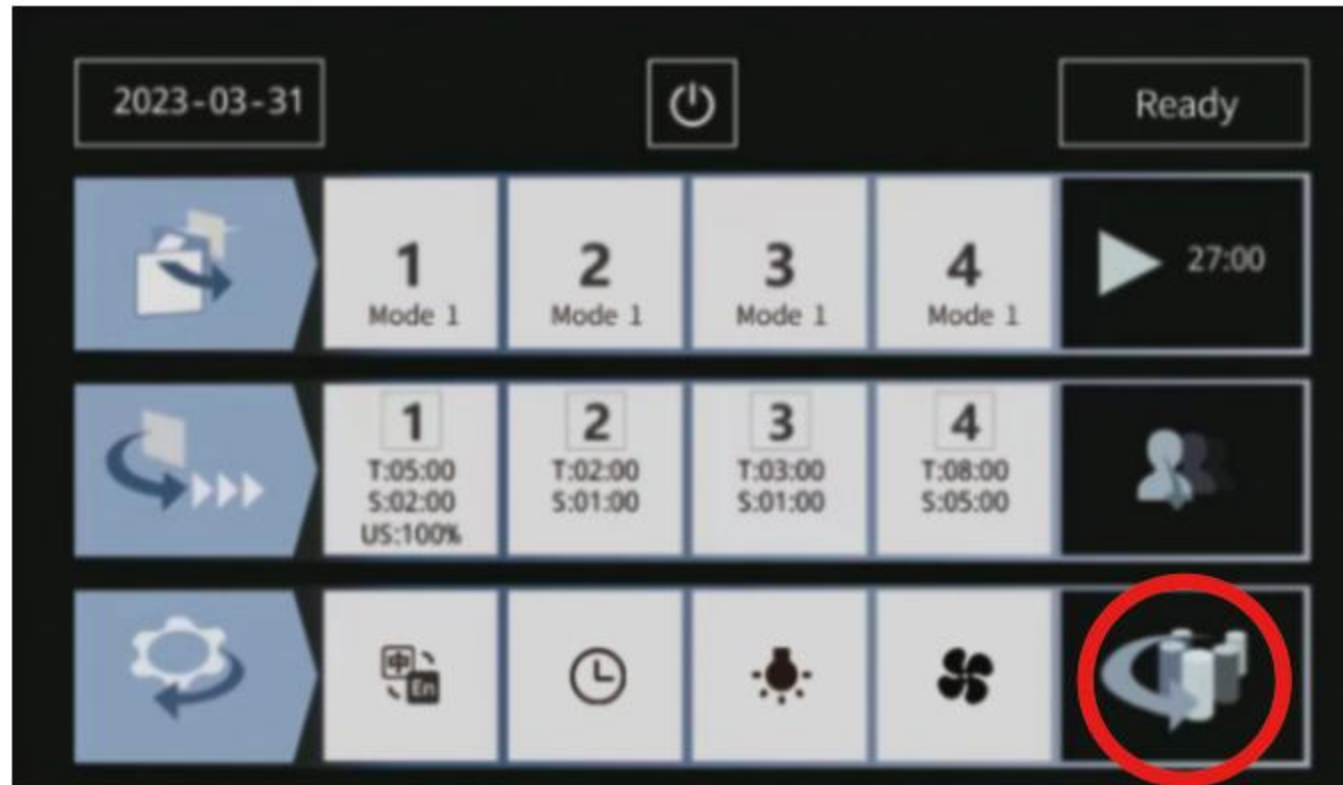

① Click the position switch button (Ensure the machine door is closed.)

② Select the empty position for greater convenience in placing baskets in the remaining compartments.

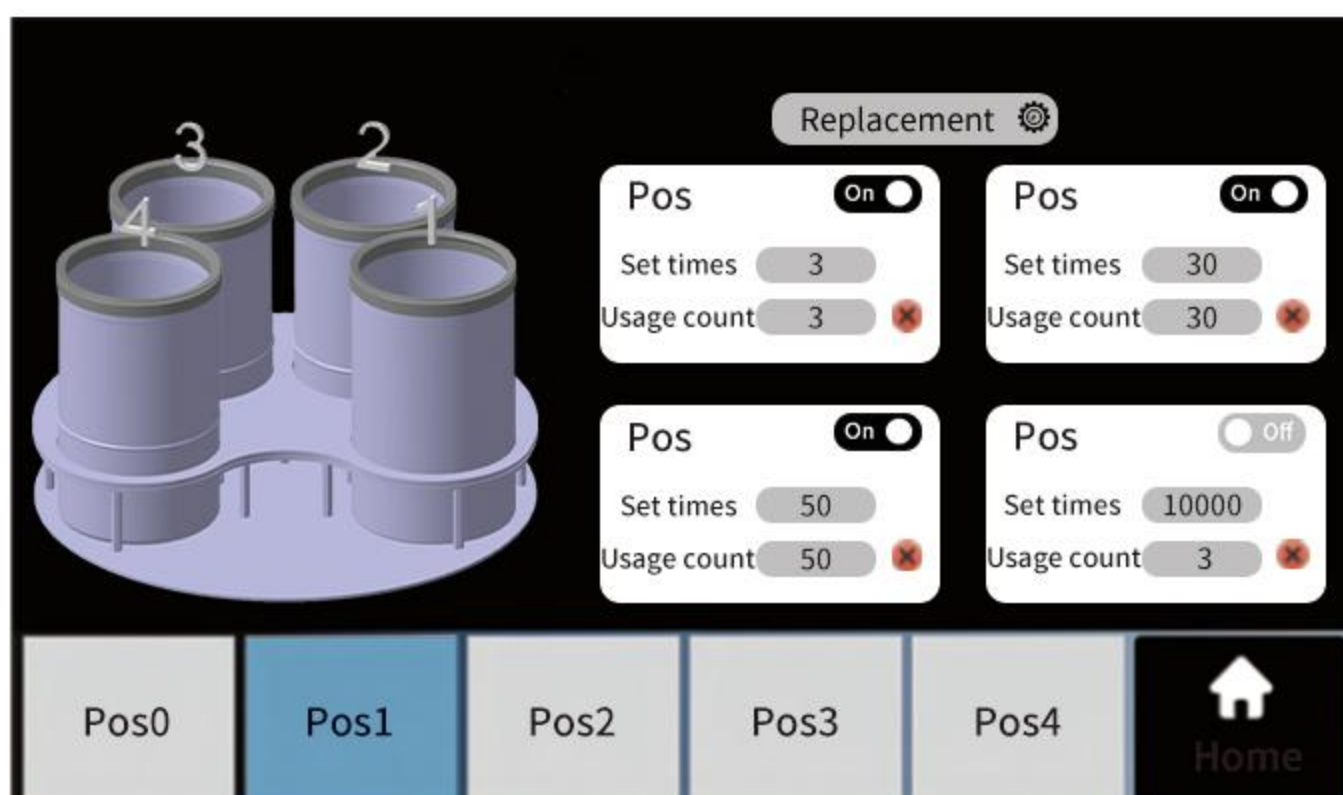

③ Click Pos1. Insert the ultrasonic metal cup and add a 1:9 ratio of watch cleaning solution to distilled water. Recommended: 10-30ml of cleaning solution, 450ml of distilled water.

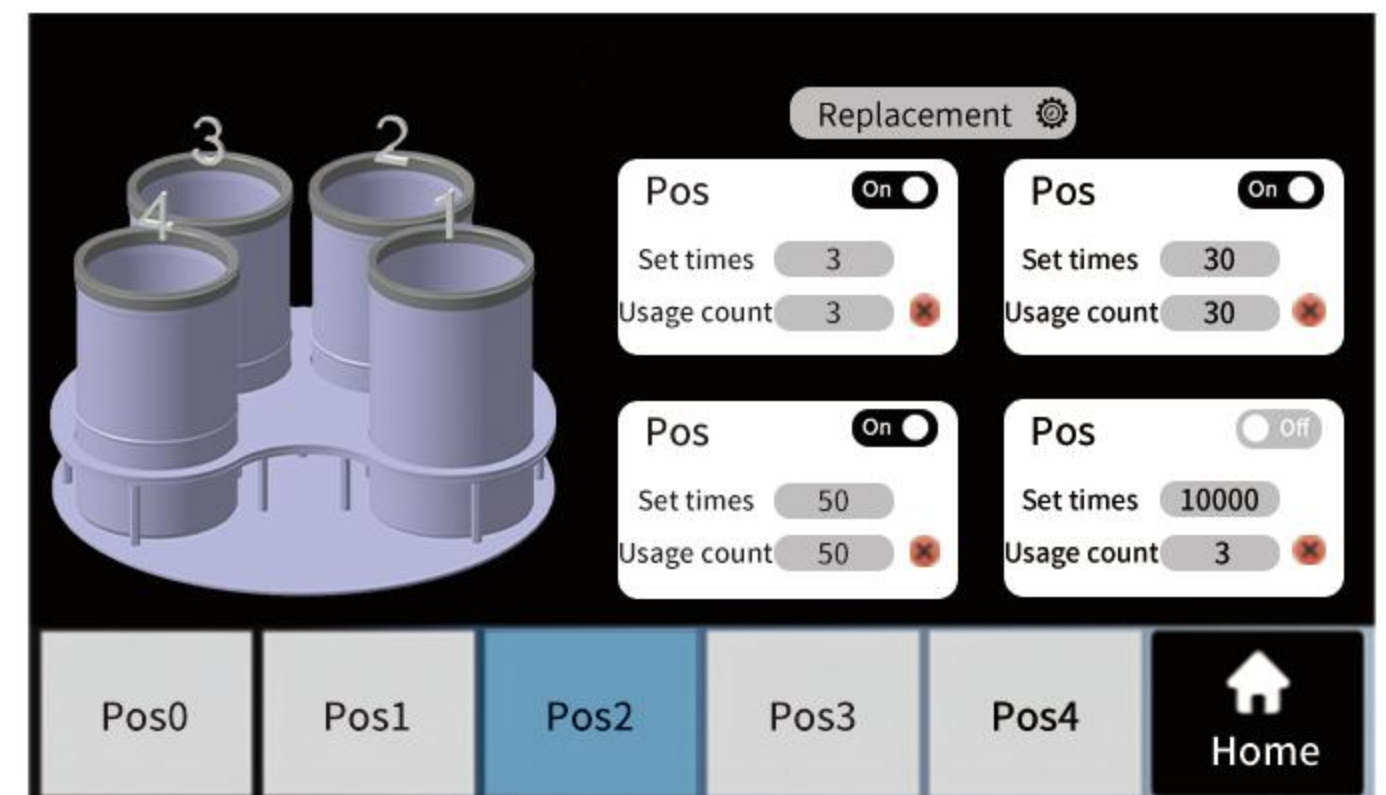

④ Click Pos2. Place a glass cup and add distilled water, filling to the MAX indicator.

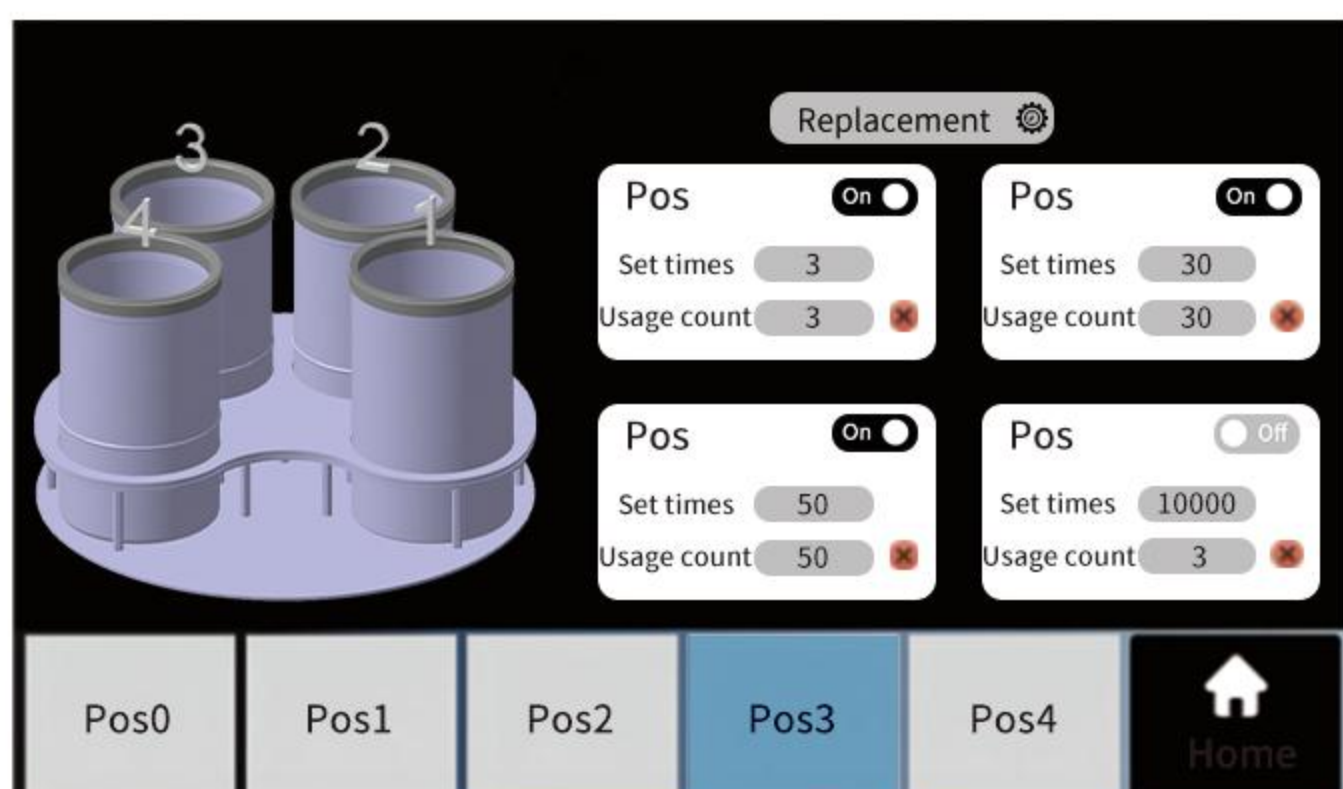

⑤ Click Pos3. Place a glass cup and add distilled water, filling to the MAX indicator.

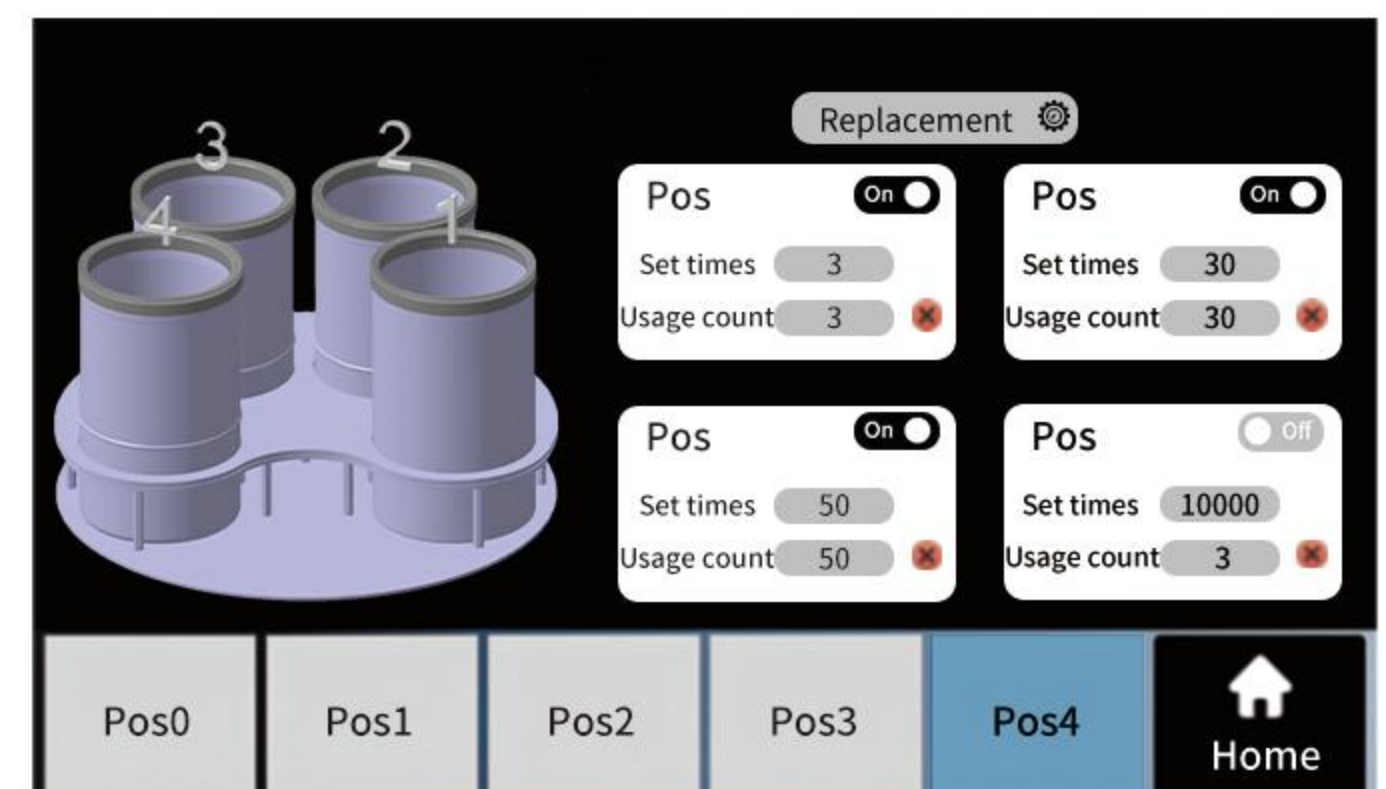

⑥ Click Pos4. Place a glass cup and add alcohol, filling to the MAX indicator. Advised alcohol concentration is above 95%.

# 04 INSTALLATION AND OPERATING INSTRUCTIONS

## SETTING CLEANING SOLUTION REPLACEMENT REMINDER

### 4. Setting cleaning solution replacement reminder:

Placing the cleaning cup, you can set the number of uses to remind you to change the cleaning solution. Using Pos1 as an example:

① Press the "ON/OFF" button to activate the reminder for Pos1.

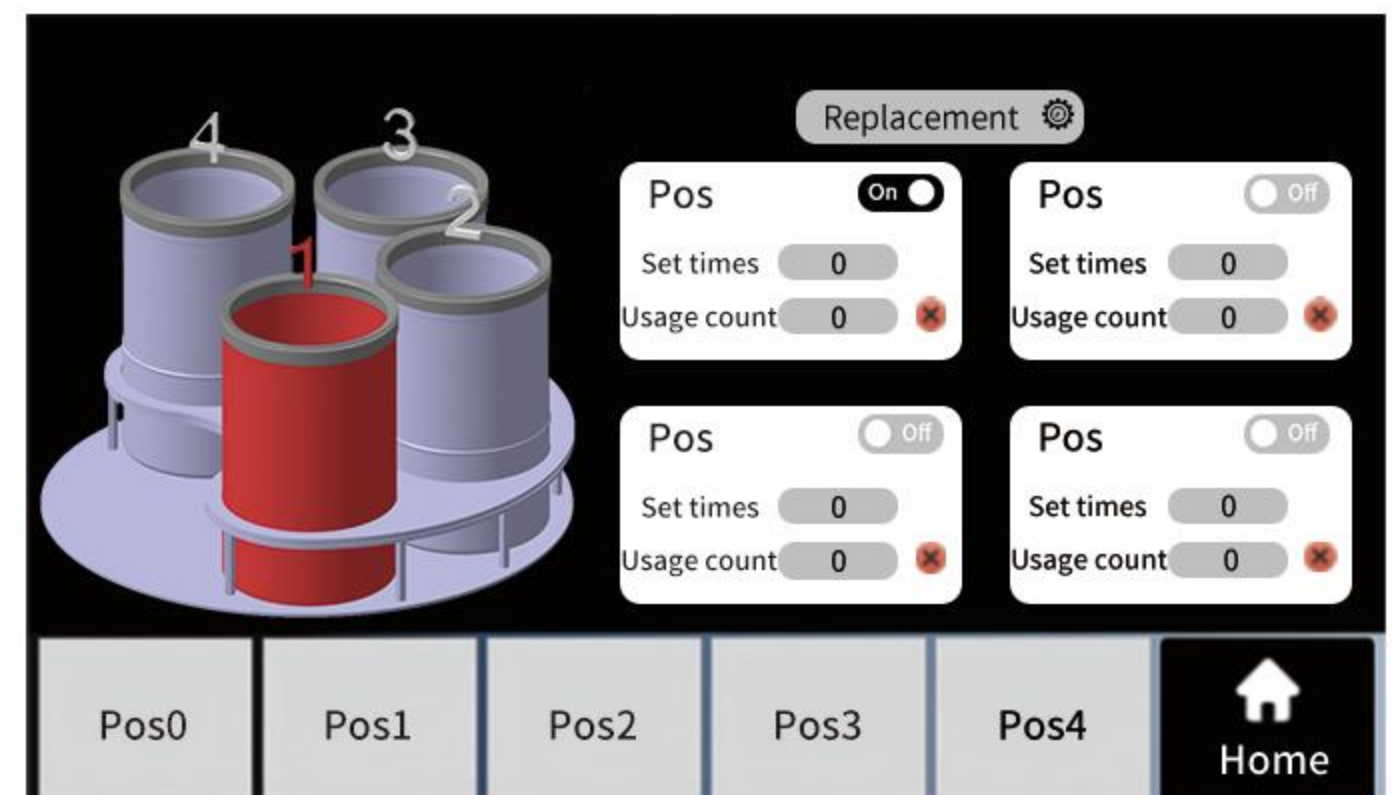

② Set the desired number of uses, illustrated here with the number 3.

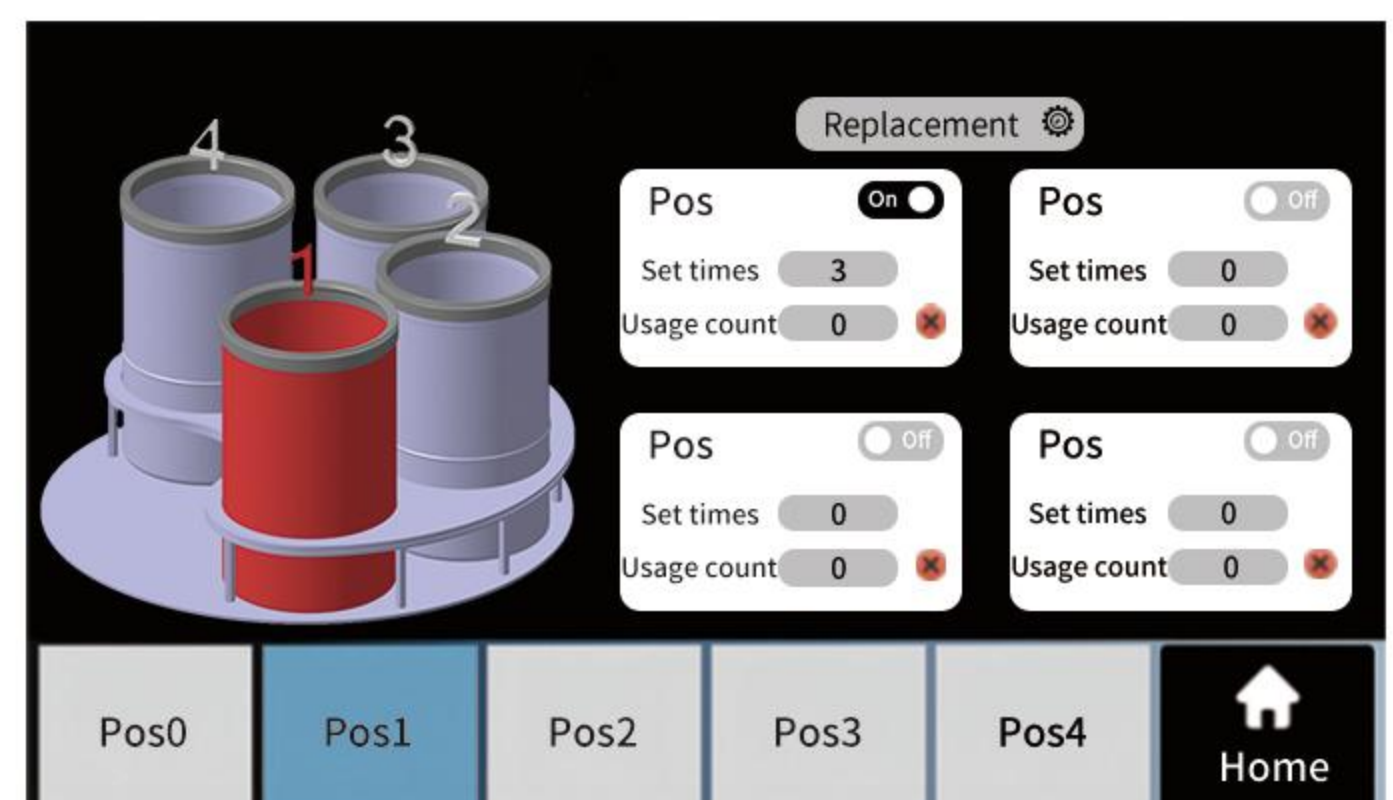

③ Once set, after each complete program, the usage count will increase. When it reaches or exceeds the set number, it will remind you to change the cleaning solution.

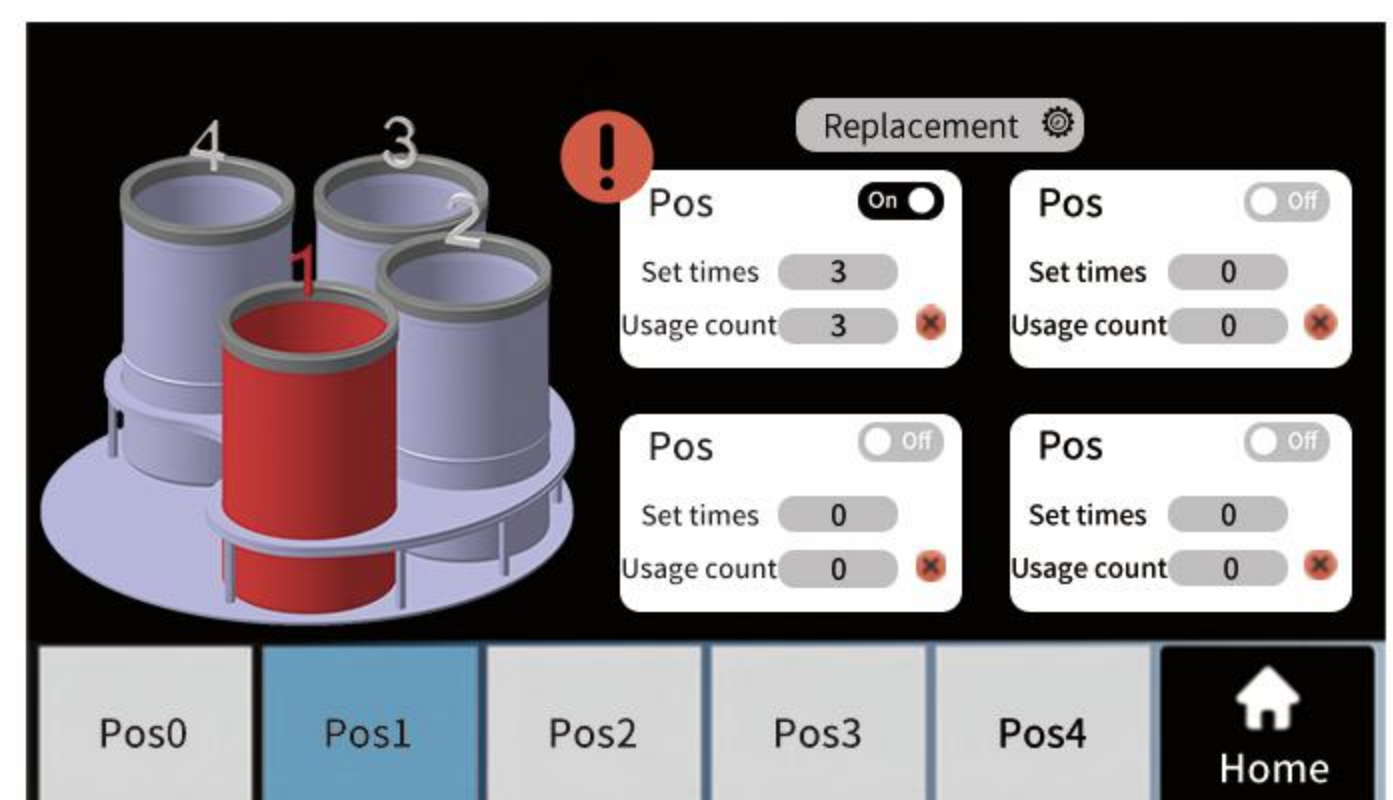

# 04 INSTALLATION AND OPERATING INSTRUCTIONS

## BASKETS&CLEANING MODE SETTING GUIDE

### 5.Usage of the basket:

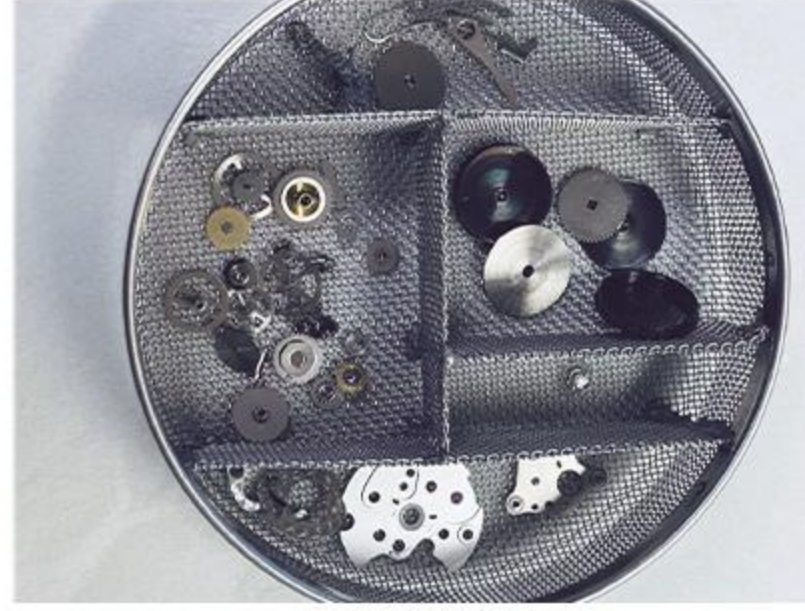
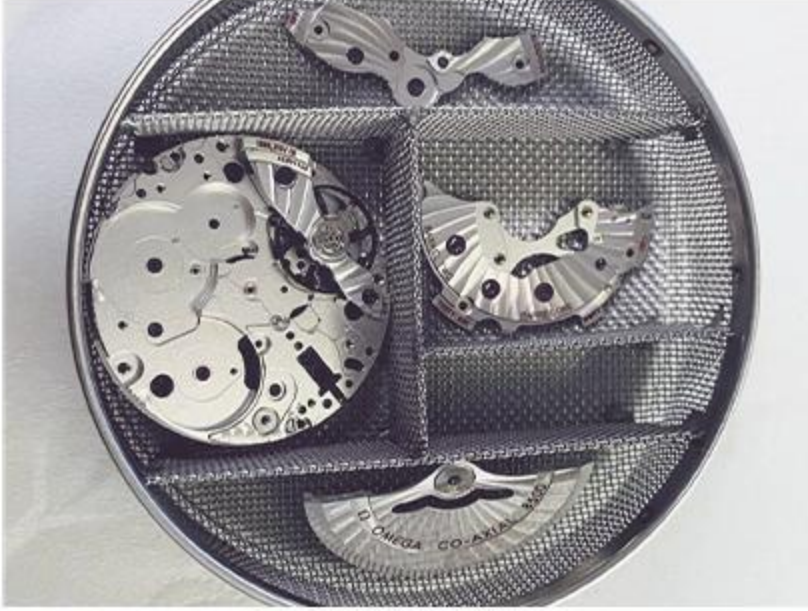

1. Place the movements into the appropriate compartments based on their size. Secure the hairsprings inside(see pictures above). Silicon hairsprings cannot be placed inside.
2. Place the holder and wheels separately, ensuring that metal wheels and copper wheels are kept apart. Place the escape wheel, second wheel, and any long wheels in a separate basket. Be aware that the escape lever and long-length springs cannot be placed inside.

### 6.Way of cleaning mode setting:

Press the compartment cleaning mode code to access the setting interface.

1. Compartment Off/On: turning off the compartment and it will not operate during the cleaning process.
2. Cleaning Mode Selection: 5 different modes available, compartments 1-4 can be set simultaneously.
3. Change of Spinning Direction: the alteration of the spinning direction during the basket's spin-drying process.
4. Spinning Speed: the rotational speed during the basket's spin-drying process.
5. Drying Compartment: the temperature of the air from the air outlet during the basket's drying process can be adjusted or set.

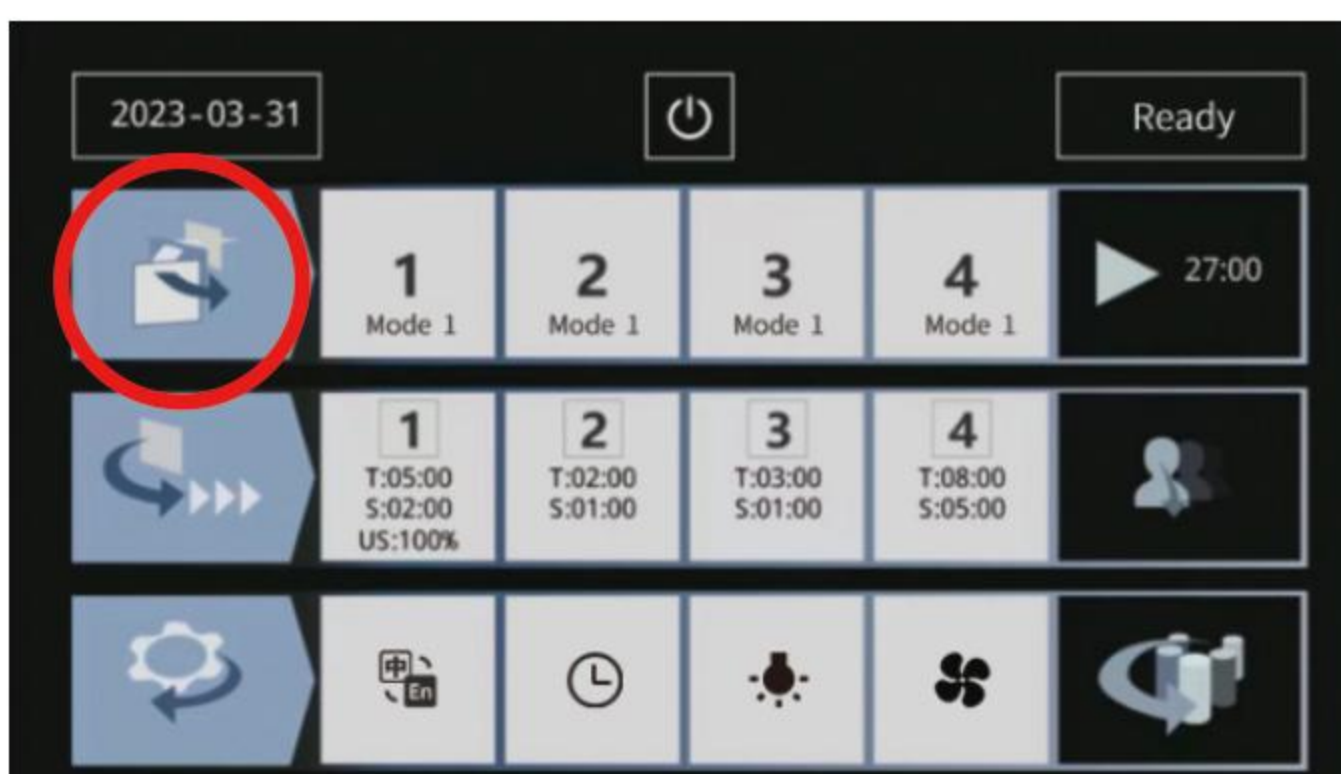

# 04 INSTALLATION AND OPERATING INSTRUCTIONS

## CLEANING MODE SETTING

### 7. Cleaning mode setting:

The cleaning density of each mode can be individually adjusted.

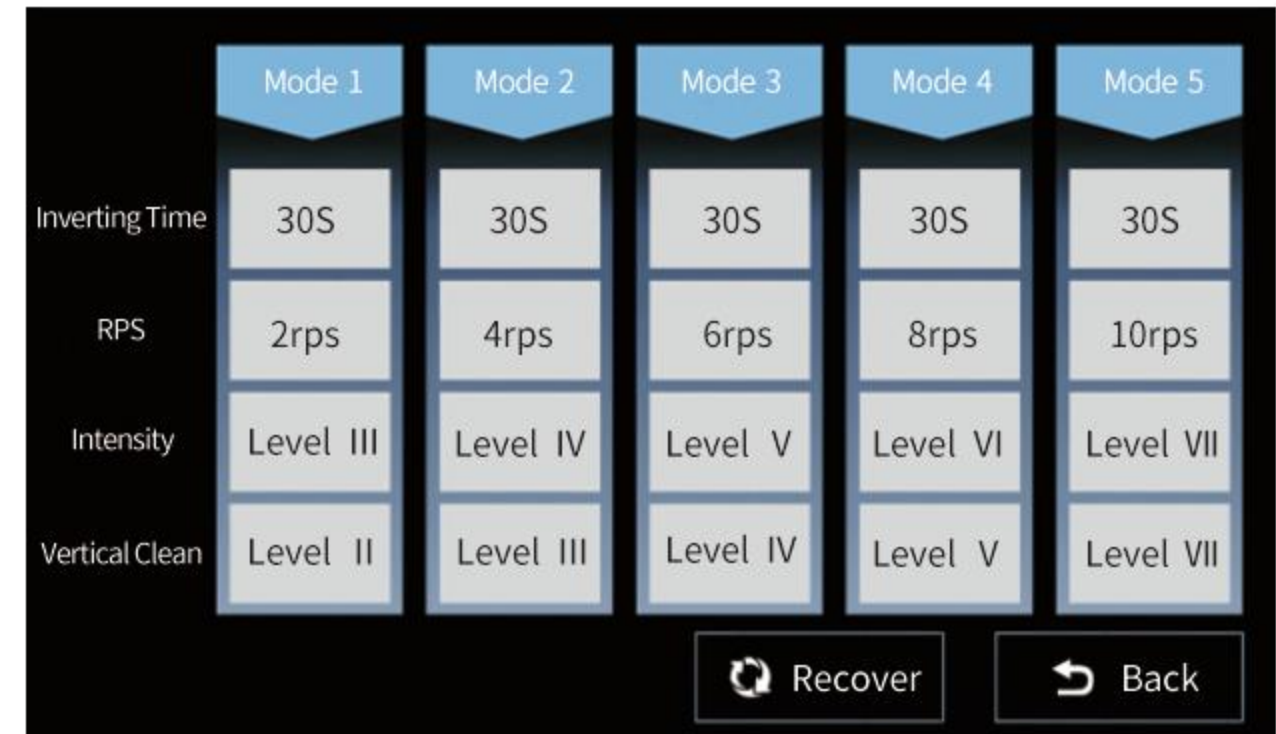

(IMAGE: THE INTERFACE DISPLAYED ON THE SCREEN AFTER TOUCHING THE CLEANING MODE CODE)

1. Change of Direction: Whether the basket will alter its direction and timing of alteration in spinning direction.

2. Rotational Speed: The rotational speed during the basket's cleaning process.

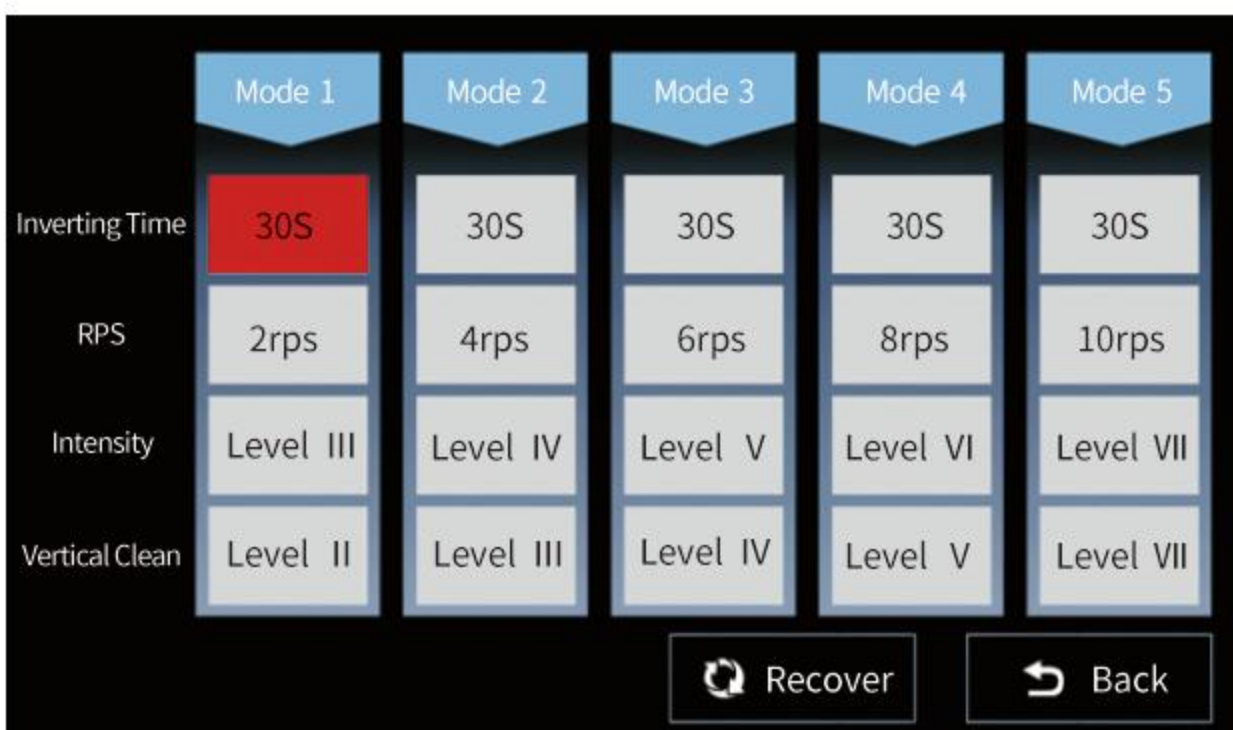

(IMAGE: SETTING INTERFACE FOR TIME OF ALTERATION IN SPINNING DIRECTION)

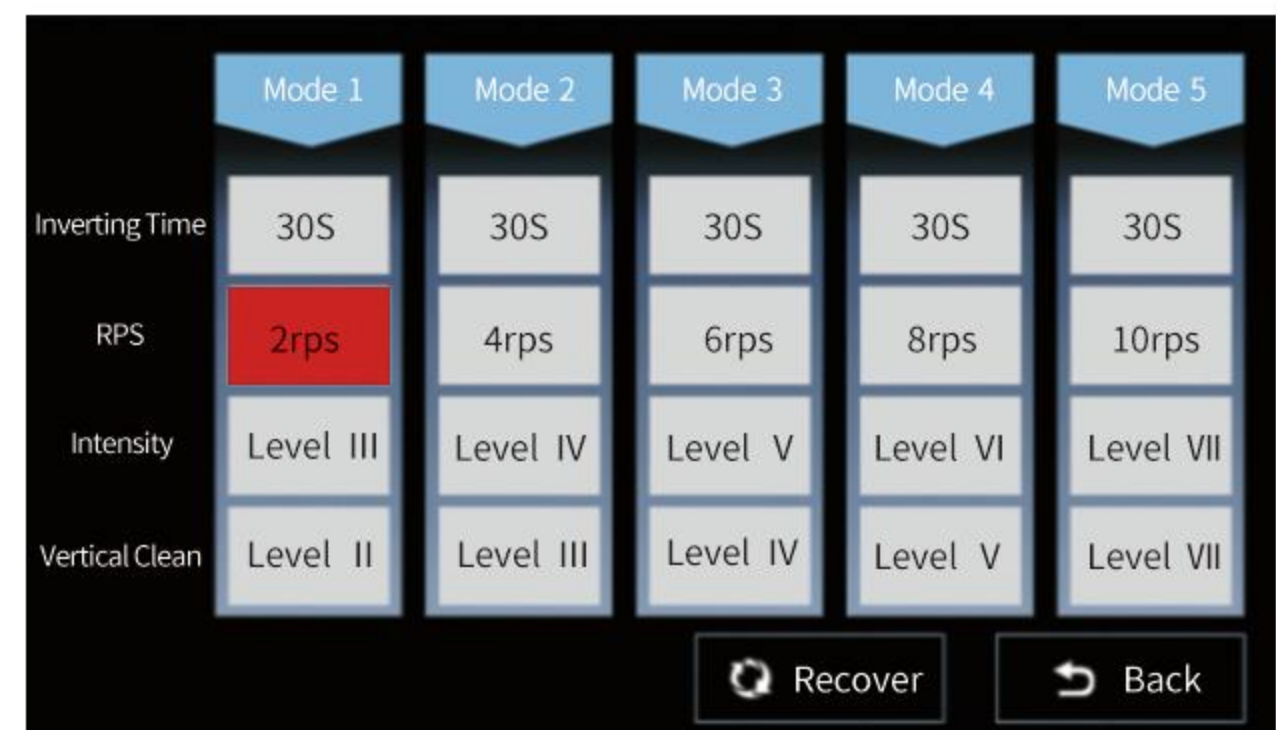

(IMAGE: SETTING INTERFACE FOR ROTATIONAL SPEED)

3. Rotational Intensity: The rotational density during the rotation of the basket.

4. Vertical Cleaning: Turning on/off or adjusting the vertical movement speed during the basket's cleaning process.



(IMAGE: SETTING INTERFACE FOR ROTATIONAL INTENSITY)



(IMAGE: SETTING INTERFACE FOR VERTICAL CLEANING)

# 04 INSTALLATION AND OPERATING INSTRUCTIONS

## CLEANING, SPIN-DRYING & STARTING

### 8. Cleaning & spin-drying time setting:

1. Cleaning Time: Refers to the designated cleaning time for a specific compartment's basket.
2. Spin-drying Time: Refers to the designated spin-drying time for a specific compartment's basket.
3. Ultrasonic: Refers to the frequency of ultrasonic vibrations for a specific compartment.
4. Drying Compartment: Refers to the designated drying time for the drying compartment.

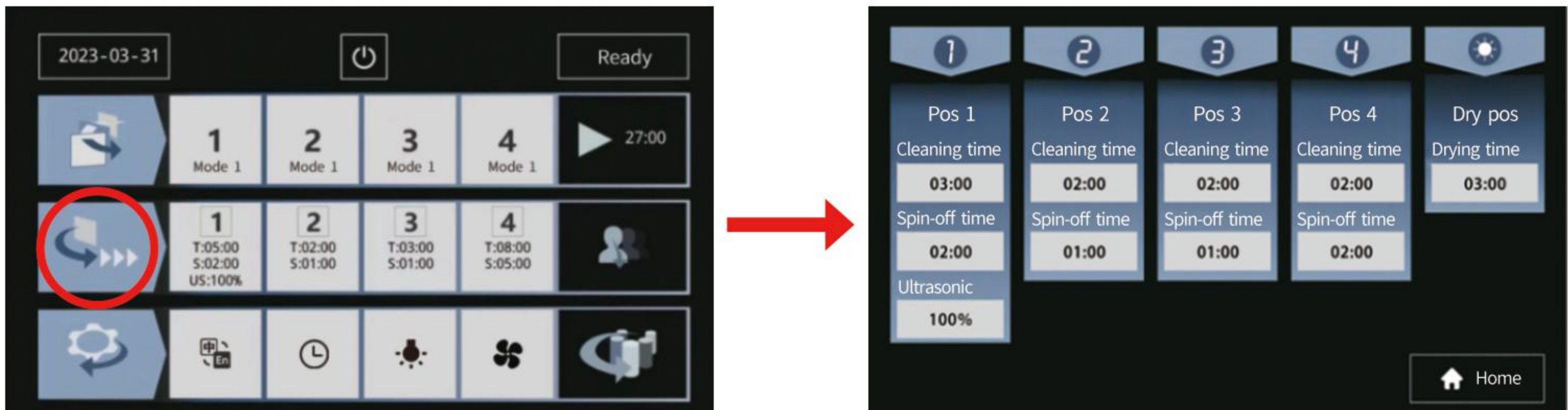

### 9. Starting and pausing the program:

1. Click the start code on the right to initiate the cleaning process. Click the pause code to stop the process. You can also press the white button on the front of the machine to start and pause the process.
2. Push the red emergency stop button on the top of the machine to halt the cleaning process. Note: the emergency stop button should be in the raised position.
3. Automatically stop the cleaning process when the door is open.
4. Select 'Stop Automatically After Spin-Drying' under normal conditions. Click the reset code to restart the process after it has been stopped.

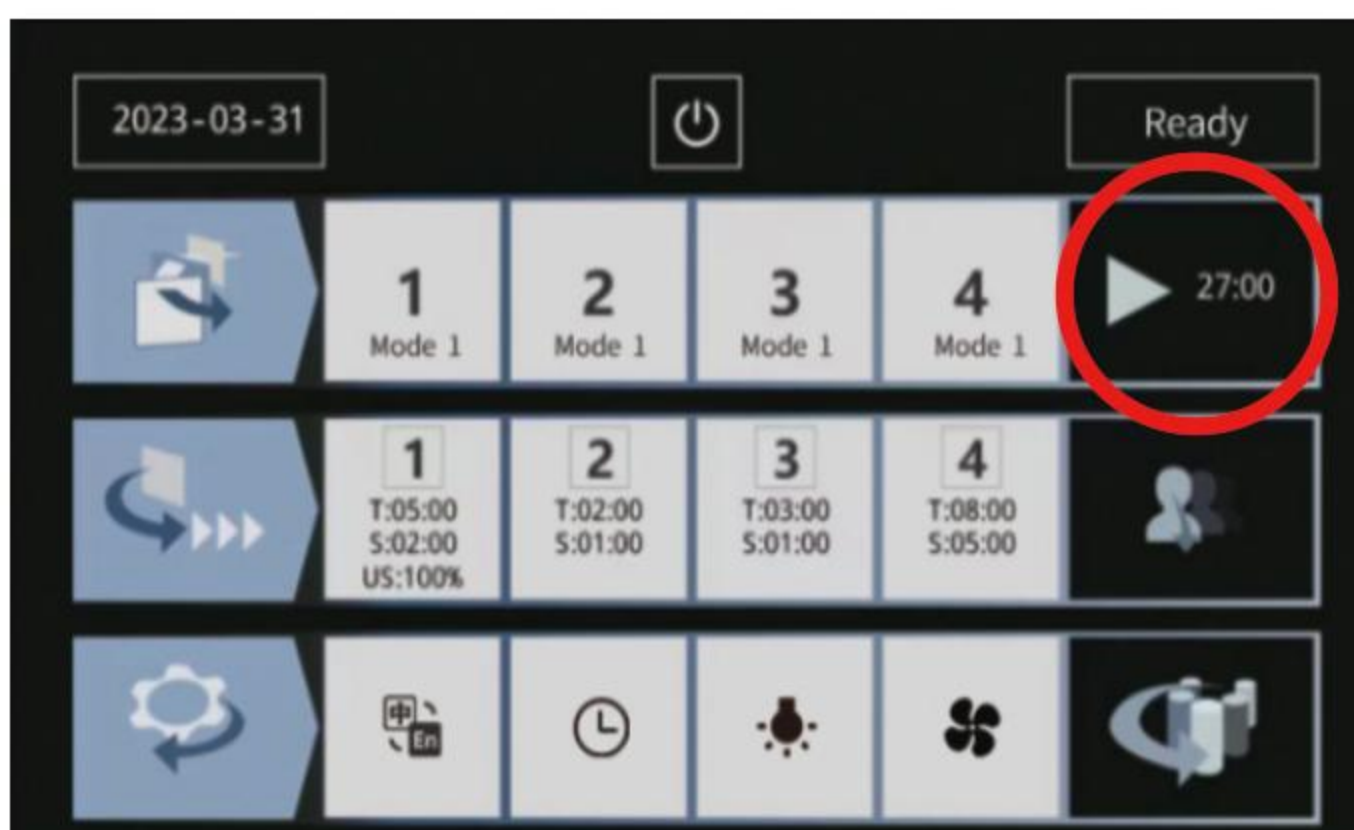

# 04 INSTALLATION AND OPERATING INSTRUCTIONS

## USER/SYSTEM SETTING & SYSTEM LANGUAGE

**10. User Setting:** The name of each user and their corresponding program settings can be configured individually.

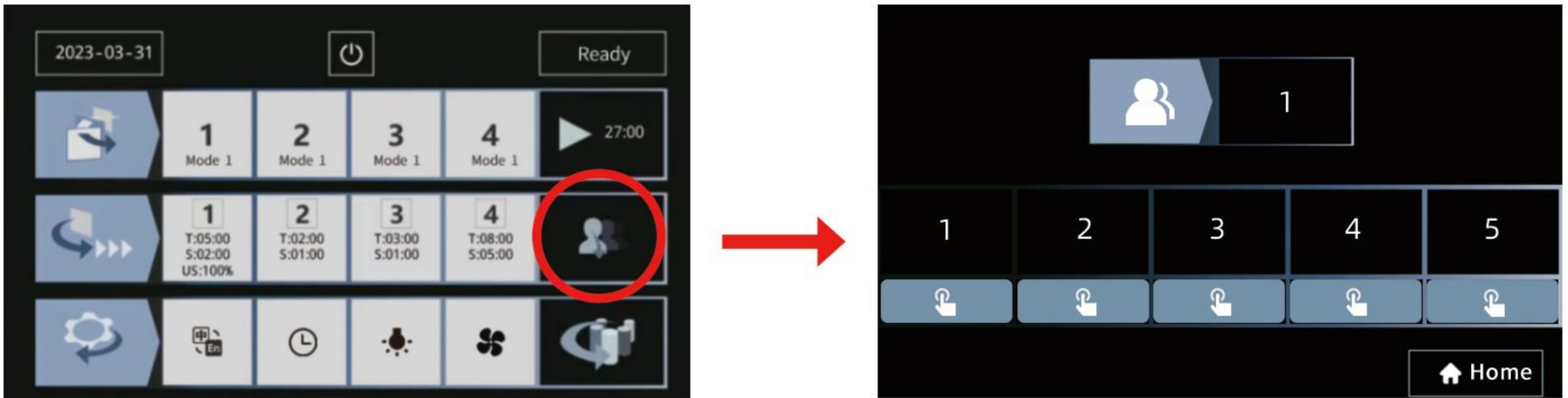

**11. System Setting:** Select silent mode or reset.

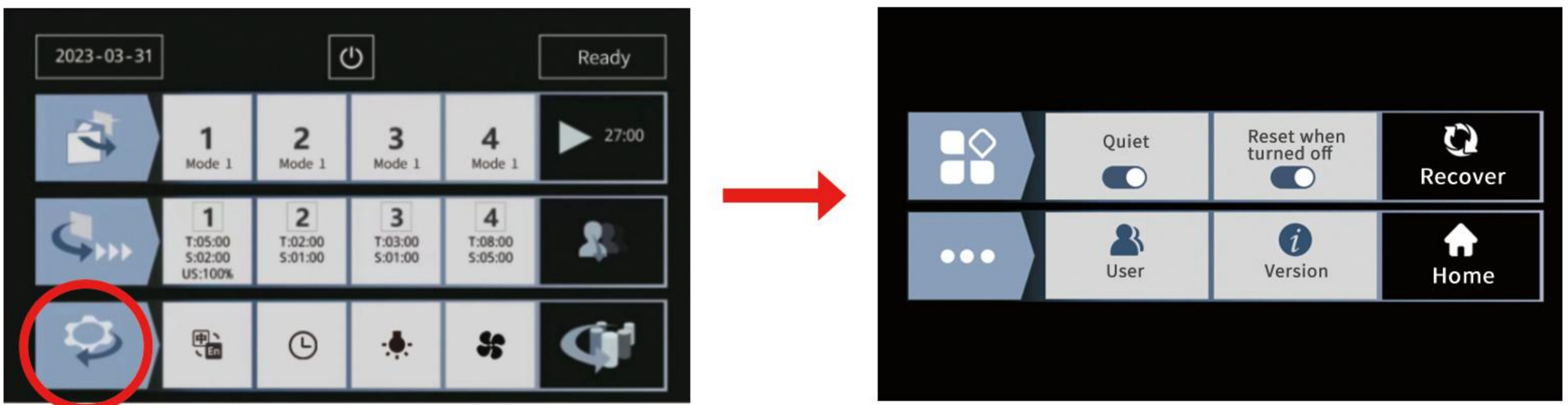

**12. System Language:** Supports simplified Chinese/traditional Chinese /English.



# 04 INSTALLATION AND OPERATING INSTRUCTIONS

## TIME/LIGHTING SETTING & SYSTEM LANGUAGE

**13.TIME SETTING:** Allows adjustment of the time displayed on the screen.



**14.LIGHTING SETTING:** Adjustment and setting of the ambient lights of the machine.

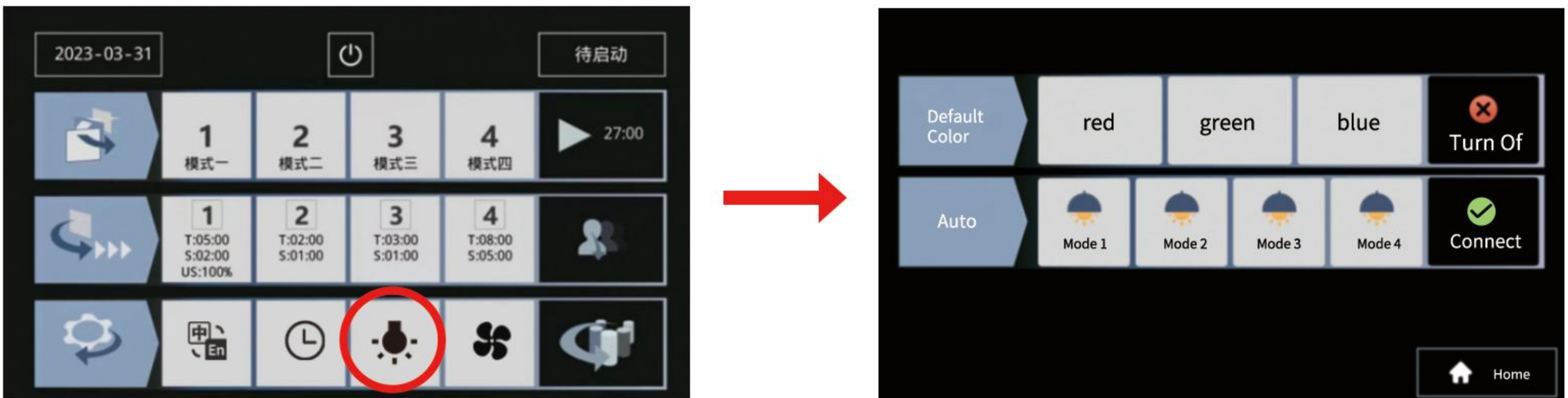

**15.VENTILATION FAN SETTING:** Adjust the gas concentration threshold to trigger the sensor.



# 05 WARRANTY AND AFTER-SALES SERVICE

## WARRANTY TERMS & AFTER-SALES SERVICE INFO



### WARRANTY TERMS:

Our product comes with a one-year warranty. This warranty covers any manufacturing defects that occur under normal operating conditions. Damages resulting from accidents, misuse, or failure to follow the product instructions are not covered under warranty.

### AFTER-SALES FRIENDLY REMINDER:

Safety is always the top priority and must be maintained at all times. All operations should strictly adhere to safety regulations. Before performing any actions that might cause damage to the equipment, we strongly recommend contacting our customer support team.

Example: Opening the device for internal cleaning or repairs should be done after consulting our customer service. Unauthorized repairs may invalidate the warranty.

The WATCHMAKERS 3.5th generation automated ultrasonic watch cleaning machine is manufactured in accordance with relevant laws and safety regulations. However, risks may still arise from misoperation or actions contrary to the instructions provided in the product manual.

The company(Panjin Chasing Light Electronic Technology Co., Ltd) is not responsible for any damage caused by the cleaning of watch movements.

The company's after-sales service offers comprehensive support, including handling customer complaints, maintenance, parts replacement, repairs, and other related requests.

### CONTACT US:

For inquiries, please contact us via the official website of the company:  
[www.wuque.com](http://www.wuque.com)



**CRAFTED  
BRILLIANCE**



**CRAFTED  
BRILLIANCE**

---